





## Adjust 'n Go

All-in-One Car Seat



**KEEP INSTRUCTIONS FOR FUTURE USE.**  
Read all instructions before using this car seat.

**WARNING**  Failure to follow the warnings on the labels and in the instruction manual can result in serious injury or death to your child.

 4358-8137  
12.17.20 

## Overview

Welcome to the Safety 1st family and thank you for choosing this car seat, also known as a child restraint!

To help you get started using your child's new car seat, here are the 4 main tasks you'll need to complete.

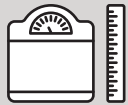

### Measure Your Child



### Adjust the Car Seat to Fit Your Child



### Install the Car Seat into Your Vehicle



### Secure Your Child in the Car Seat

Your child's safety is worth the time it will take to read and follow these instructions.

#### Ready? Let's go!

**Pages 1-3** will introduce you to the parts of the car seat.

**Page 78** has our contact information. If at any point you would like assistance, please feel free to reach out to us.

## Quick Navigation

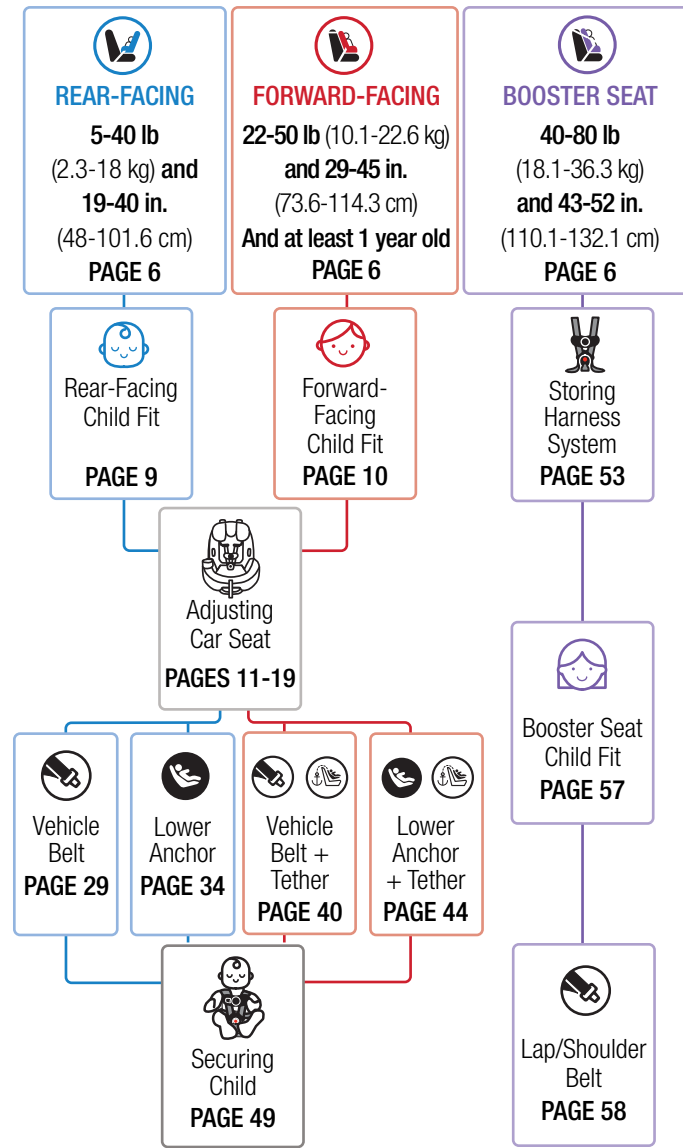

# Contents

## Getting Started

Parts of the Car Seat .....	1
Accessory Use .....	4
Choosing Car Seat Mode .....	5
Preparing Car Seat for Child Fit.....	7
Rear-Facing Child Fit .....	9
Forward-Facing Child Fit .....	10

## Making Adjustments to Car Seat

Changing Headrest/Harness Height .....	11
Changing Buckle Position .....	12
Harness System Adjustments for Smaller Infants .....	15
Reclining the Car Seat .....	19

## Choosing LATCH or Vehicle Belt

LATCH: Lower Anchor Use .....	20
Vehicle Belts .....	22
Tether Use .....	26

## Installation in Vehicle

Rear-Facing Mode .....	28
Rear-Facing Vehicle Belt Install.....	29
Rear-Facing LATCH: Lower Anchor Install .....	34
Forward-Facing Mode .....	39
Forward-Facing Vehicle Belt + Tether Install.....	40
Forward-Facing LATCH: Lower Anchor + Tether Install.....	44

## Securing Child in Car Seat..... 49

### Booster Seat

Booster Seat Mode .....	52
Storing Harness System .....	53
Booster Seat Child Fit .....	57
Lap/Shoulder Belt Use .....	58

## Wash & Care of Car Seat Parts

Removing Seat Pad Set for Cleaning .....	60
Cleaning Parts of Car Seat and Installing Seat Pad Set .....	63
Installing Harness System .....	66

## Safety Information

Aircraft Information .....	70
Replacement and Expiration of Car Seat .....	71
Child Restraint Use.....	72
Installation in Vehicle.....	72
Vehicle Seating Position .....	73
Registration and Safety Notices.....	74

## Additional Information

Warranty .....	75
Troubleshooting .....	76
Replacement Parts List .....	77
Dorel Juvenile Group Information.....	78

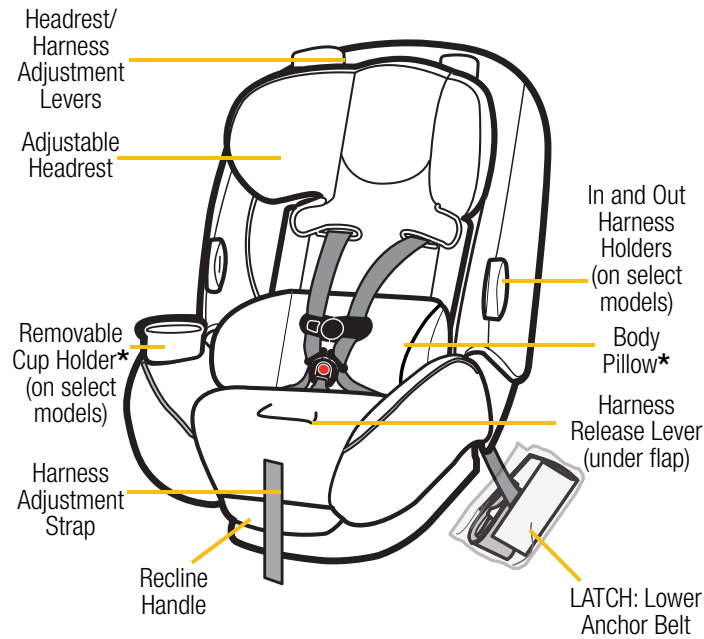

\*See page 4 for Accessory Use.

Harness System Detail

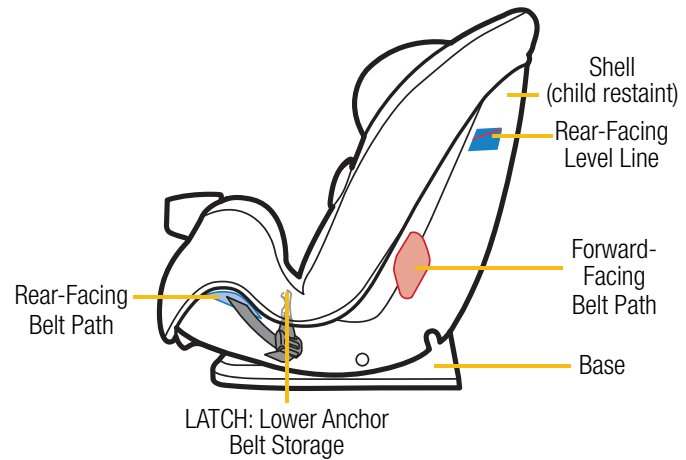
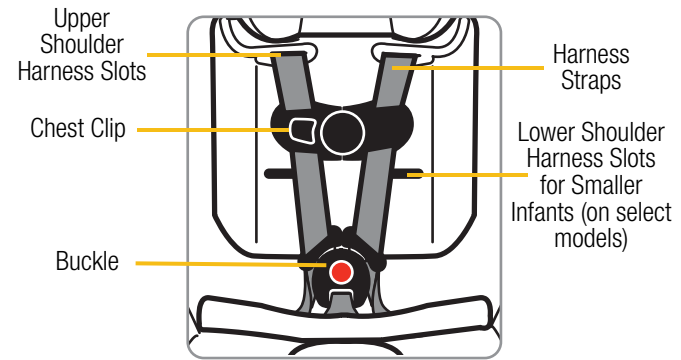

continued on next page

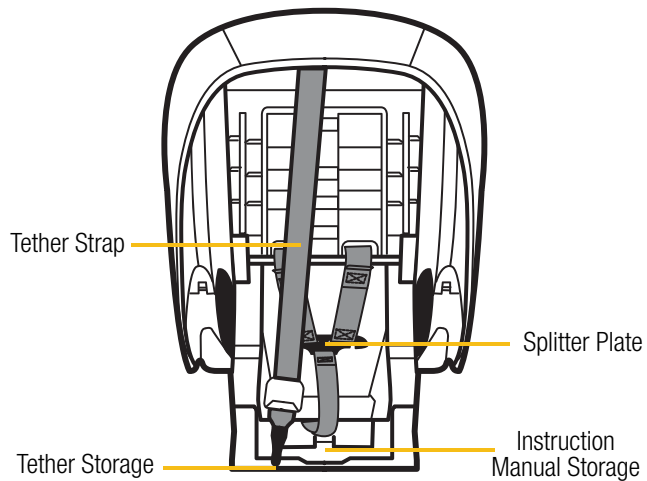

For Use in Rear-Facing Mode Only

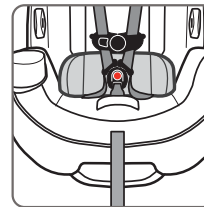

### Body Pillow

When using the lower shoulder harness slots for smaller infants, you **MUST** use the body pillow.

To remove **body pillow**, slide pillow out from behind the harness straps.

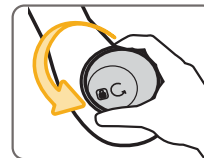

### Removable Cup Holder (on select models)

The cup holder is top-rack dishwasher safe.

To remove **cup holder**, twist the cup holder counterclockwise. Pull it out of slot in shell.

To install **cup holder**, align tabs on bottom of cup holder with slots in shell. Twist clockwise to lock in place.

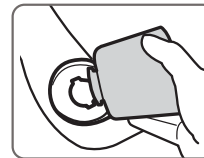



**Measure your child's weight and height (do not guess) before choosing the car seat's mode.**

Your child's height, weight, and age determine how the car seat should be placed in the vehicle.

Children vary widely in body size, shape, and temperament—**please consult your doctor before switching between any of these modes within the limits and fit requirements of the seat.**

### State Laws

Please be certain to follow your state's laws regarding car seat use.

### American Academy of Pediatrics Recommendations

#### Infants and Toddlers

Should ride in a rear-facing car seat as long as possible, until they reach the highest weight or height allowed by their seat.

#### Toddlers and Preschoolers

Once they are facing forward, children should use a forward-facing car seat with a harness for as long as possible, until they reach the height and weight limits for their seats.

#### School-Aged Children

Once they have outgrown their forward-facing car seat, children should use a belt-positioning booster seat until the vehicle's lap and shoulder seat belt fits properly. This is often when they have reached at least 4 feet 9 inches in height and are 8 to 12 years old.

#### Older Children

All children younger than 13 years should be restrained in the rear seats of vehicles for optimal protection.



### REAR-FACING MODE

**5-40 lb (2.3-18 kg) and 19-40 in. (48-101.6 cm)**

Children under 1 year of age must ride **Rear-Facing**.

**In this car seat, your child can remain Rear-Facing until they outgrow any one of the following:**

- **Weight Limit:** 40 lb (18 kg); **OR**
- **Height Limit:** 40 in. (101.6 cm); **OR**
- **Rear-Facing Child Fit** requirements, see page 9



### FORWARD-FACING MODE

**22-50 lb (10.1-22.6 kg) and 29-45 in. (73.6-114.3 cm)**

Children must be at least 1 year of age to ride **Forward-Facing**.

**In this car seat, your child can remain harnessed Forward-Facing until they outgrow any one of the following:**

- **Weight Limit:** 50 lb (22.6 kg); **OR**
- **Height Limit:** 45 in. (114.3 cm); **OR**
- **Forward-Facing Child Fit** requirements, see page 10



### BOOSTER SEAT MODE

**40-80 lb (18.1-36.3 kg) and 43-52 in. (110.1-132.1 cm)**

**In this car seat, your child can remain in a Booster Seat until they outgrow any one of the following:**

- **Weight Limit:** 80 lb (36.3 kg); **OR**
- **Height Limit:** 52 in. (132.1 cm); **OR**
- **Booster Seat Child Fit** requirements, see page 57

## Preparing Car Seat for Child Fit

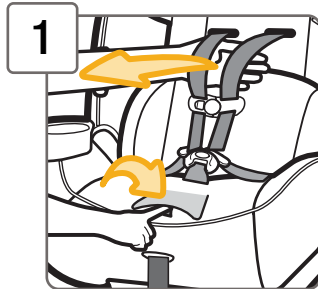

### Fully Loosen Harness Straps

Push down on harness release lever (through opening in pad) while pulling out on harness straps as shown.

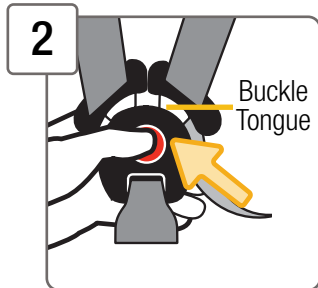

### Unbuckle Harness

Press in towards the **top** of the red button to release the buckle tongues.

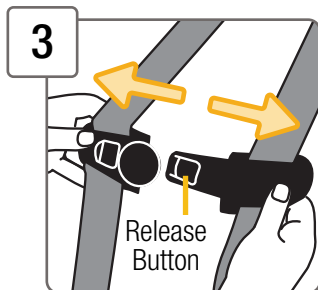

### Release Chest Clip

Hold each side of the chest clip and press on the release button with your thumb and pull apart.

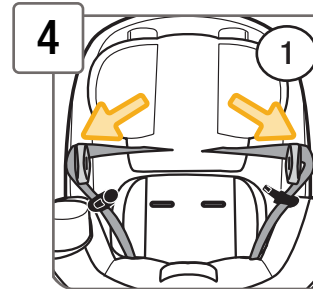

### Place Harness Straps Out of the Way

The In and Out Harness Holders (on select models) can be used two ways:

1. You can secure the harness straps around them as shown.
2. Or the buckle tongues can be placed into the slots in the harness holders as shown.

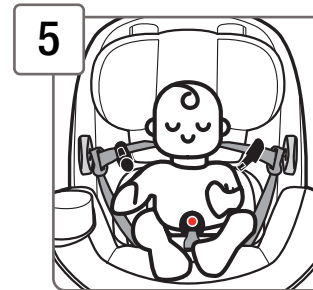
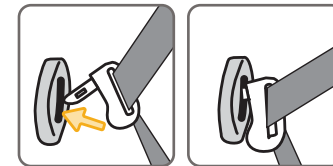
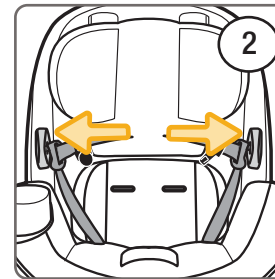

### Place Child in Car Seat to Determine Proper Harness Fit

The child's bottom and back should be flat against the car seat.

For **Rear-Facing** child fit, see page 9.

For **Forward-Facing** child fit, see page 10.

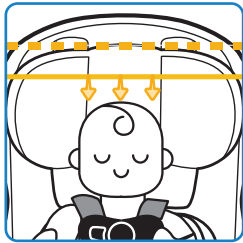

### Head Position

The top of your child's head **must be at least 1 in. (2.5 cm) below** the top of the car seat's headrest.

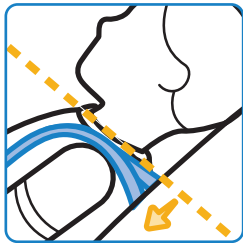

### Harness Strap Position

The harness strap **must be at or slightly below** the shoulders; **never above.**

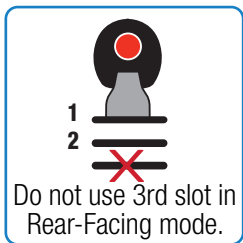

### Buckle Position

Buckle must be used in either the **1st or 2nd slot**. Choose the slot closest to your child.

The buckle **should not be underneath or behind** your child.

#### Need to make adjustments?

To change headrest/harness height, see page 11.

To change buckle position, see pages 12-14.



### Head Position

The tops of your child's ears **must be below** the top of the car seat's headrest.

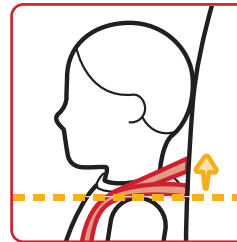

### Harness Strap Position

The harness strap **must be at or slightly above** the shoulders; **never below.**

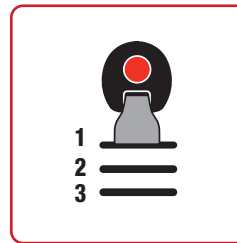

### Buckle Position

Buckle can be used in **any slot**. Choose the slot closest to your child.

The buckle **should not be underneath or behind** your child.

#### Need to make adjustments?

To change headrest/harness height, see page 11.

To change buckle position, see pages 12-14.



## Changing Headrest/ Harness Height

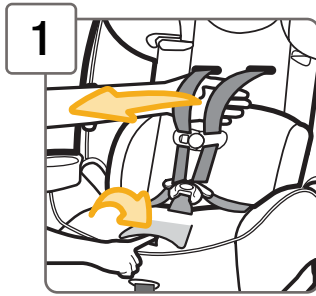

### 1 Fully Loosen Harness Straps

Push down on harness release lever (through opening in pad) while pulling out on harness straps as shown.

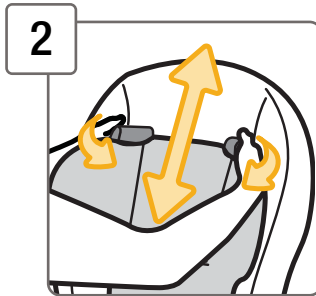

### 2 Changing Headrest/ Harness Height

Rotate the headrest/harness adjustment levers inward.

Move the headrest up or down to the proper height for your child.

Release headrest adjustment levers to lock in place.

**Make sure it is locked securely.**

For **Rear-Facing Child Fit**, see page 9.

For **Forward-Facing Child Fit**, see page 10.

Check your child's fit often.

If you cannot achieve a snug harness fit for your child, see pages 15-18.

To learn how to check harness tightness, see pages 49-51.

Check the harness straps often for any wear or damage.

## Changing Buckle Position

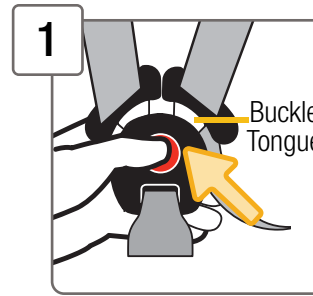

1

### 1 Unbuckle Harness

Press in towards the **top** of the red button to release the buckle tongues.

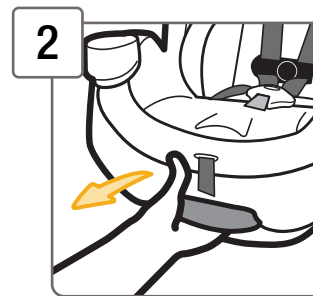

2

### 2 Fully Recline the Car Seat

Pull out on recline handle and push top of child restraint back.

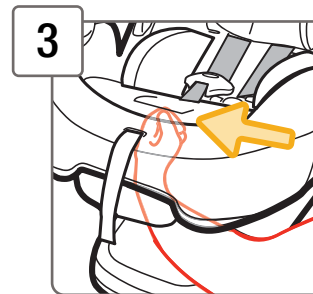

3

### 3 Locate the Buckle's Metal Retainer

Reach under the seat between the base and shell and through the recline handle.

*continued on next page*

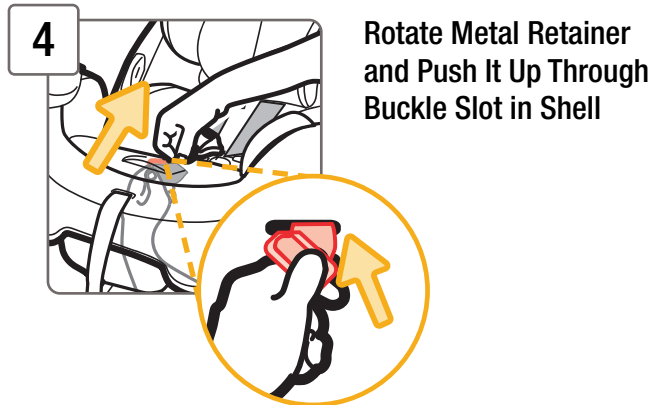

**4** Rotate Metal Retainer and Push It Up Through Buckle Slot in Shell

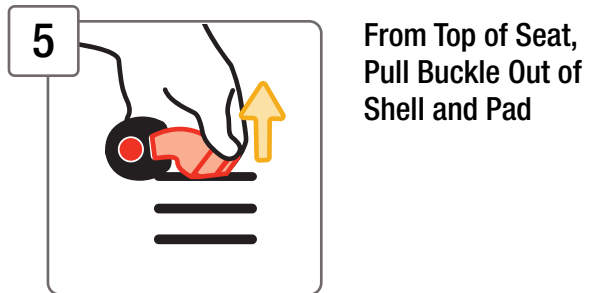

**5** From Top of Seat, Pull Buckle Out of Shell and Pad

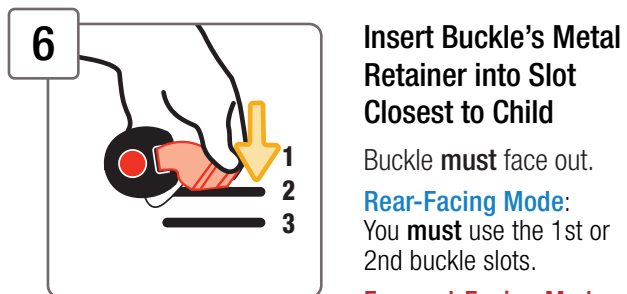

**6** Insert Buckle's Metal Retainer into Slot Closest to Child

Buckle **must** face out.

**Rear-Facing Mode:**  
You **must** use the 1st or 2nd buckle slots.

**Forward-Facing Mode:**  
Any slot can be used.

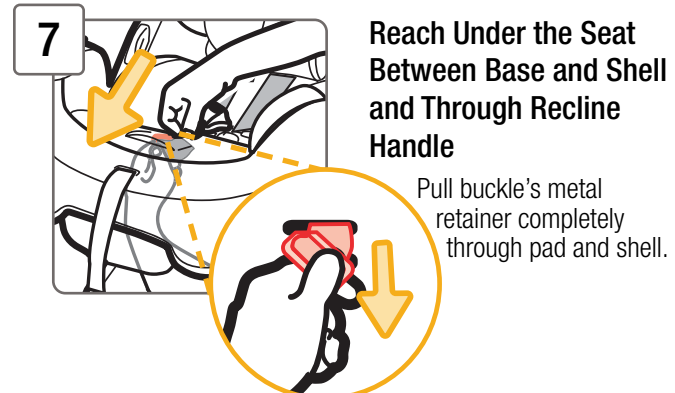

**7** Reach Under the Seat Between Base and Shell and Through Recline Handle

Pull buckle's metal retainer completely through pad and shell.

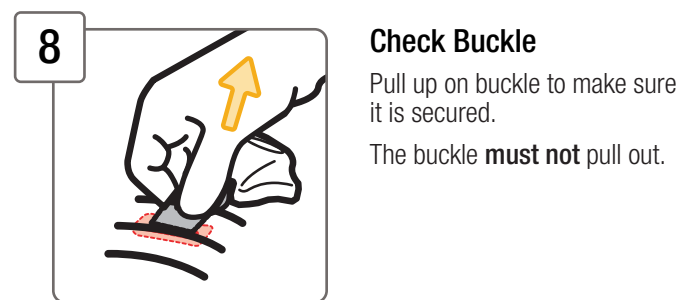

**8** Check Buckle

Pull up on buckle to make sure it is secured.

The buckle **must not** pull out.

Check your child's fit often.

If you cannot achieve a snug harness fit for your child, see pages 15-18.

To learn how to check harness tightness, see pages 49-51.

**⚠ Failure to place buckle's metal retainer completely through pad and shell can result in serious injury or death.**

## Harness System Adjustments for Smaller Infants

If you cannot achieve a snug harness fit for your child, you may need to adjust the buckle strap and/or harness strap length and location as shown in this section.

### Adjusting Buckle Strap

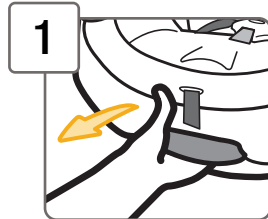

1

#### With Buckle in the 1st Slot, Fully Recline the Car Seat

If you need to move the buckle to the 1st slot, see pages 12-14.

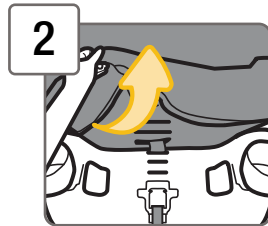

2

#### Pull Up Front of Car Seat Pad

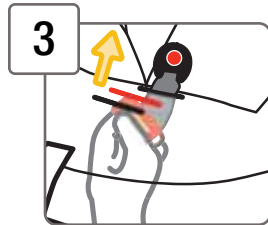

3

#### From Bottom of Seat, Pull Metal Retainer Down and Push It Up into Middle Slot As Shown

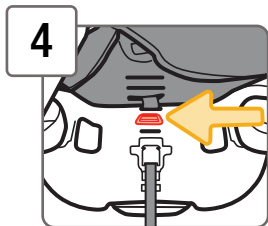

4

#### From Top of Seat, Lay the Metal Retainer Flat Against the Shell As Shown

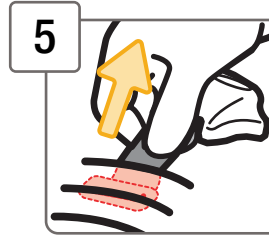

5

#### Tuck Car Seat Pad Back Around Front of Car Seat and Check Buckle

Pull up on buckle to make sure it is secured.

The buckle **must not** pull out.

Check your child's fit often.

To learn how to check harness tightness, see pages 49-51.

### Adjusting Harness Strap

When using the lower shoulder harness slots for smaller children, you **MUST** use the body pillow and the headrest **MUST** be in the lowest position.

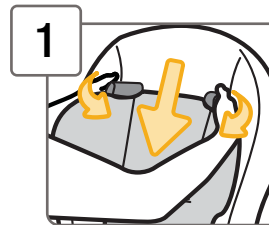

1

#### Adjust the Headrest to the Lowest Position

The headrest **must** be in the lowest position.

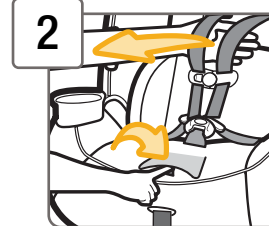

2

#### Fully Loosen Harness Straps

Push down on harness release lever (through opening in pad) while pulling out on harness straps as shown.

*continued on next page*

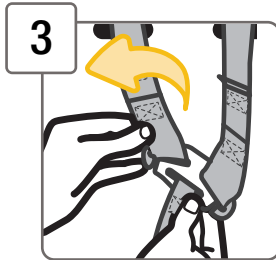

**3** From Back of Seat,  
Remove Harness Strap  
Loops From Splitter Plate

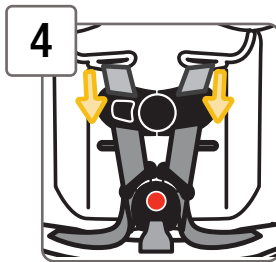

**4** Pull Harness Straps Out of  
Upper Shoulder Harness  
Slots

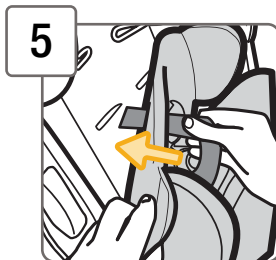

**5** Pull Body Pillow Forward  
Away from Seat

Thread harness straps through slots  
in body pillow.

You **must** use the body pillow.



**6** Thread Harness Straps  
Through Lower Shoulder  
Harness Slots For Smaller  
Infants in Seat Pad and Shell

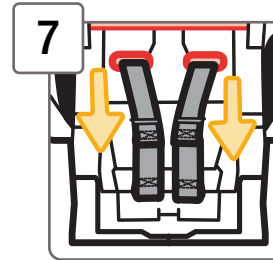

**7** From Back of Seat, Pull  
Harness Straps Through  
Shell

Harness straps **must** be in shoulder  
harness slots **below** the metal bar  
as shown.

Do **not** twist harness straps.

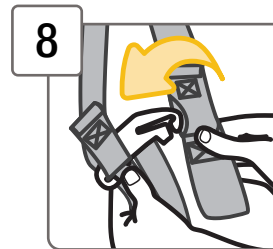

**8** Attach 2nd Harness Strap  
Loops to Splitter Plate As  
Shown

Sewn ends of the harness strap loops  
**must** face towards you.

Do **not** twist harness straps or  
harness adjustment strap.

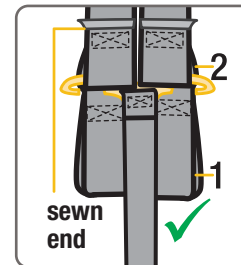

Make sure the same harness strap  
loops are fitted **completely** on both  
sides of the splitter plate.

Check your child's fit often.

To learn how to check harness  
tightness, see pages 49-51.

The harness strap **must** be returned  
to the upper shoulder harness slots  
as your child grows.

**⚠** The harness system must be installed correctly. Do not  
use a child restraint with damaged harness straps.

This car seat has 3 positions.

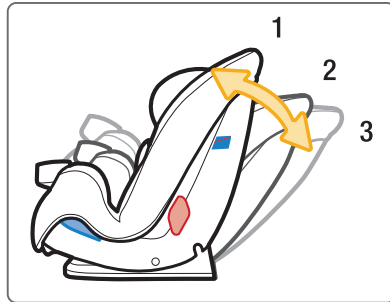

**Rear-Facing Mode** - 3 Reclined or 2 Semi-reclined

For children who cannot sit up unassisted, the level line on shell **must** be parallel with the ground using either Position 3 or 2.

For children who can sit up unassisted, you may rotate the child restraint to be more upright in Position 2.

**Forward-Facing Mode** - 1 Upright or 2 Semi-reclined

**Booster Seat Mode** - 1 Upright or 2 Semi-reclined

**NOTE:** When used in **Forward-Facing** or **Booster Seat** mode, the semi-reclined position is to be used only to install the child restraint or booster seat flush against the vehicle seat back. Vehicle seat back must be upright.

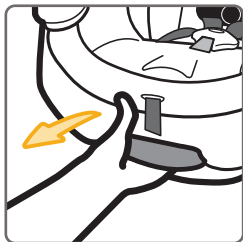

**To Recline:** Pull out on recline handle and push top of child restraint back.

**For More Upright:** Pull out on recline handle and pull top of child restraint forward.



For Use in Rear-Facing or Forward-Facing Mode

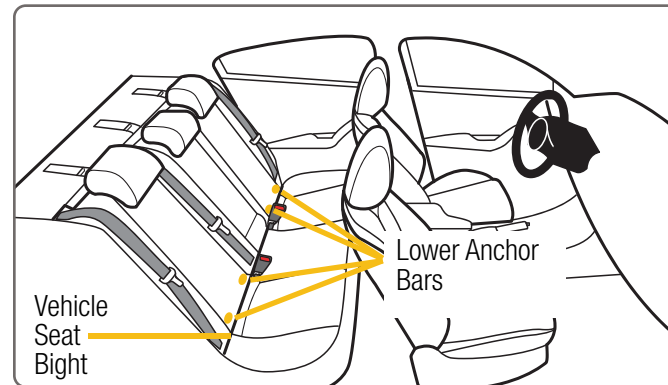

Your vehicle's features may be considerably different than those pictured here.

The lower anchors of LATCH (Lower Anchors and Tethers for Children) is a universal system for installing child restraints without using vehicle seat belts.

The lower anchor can **ONLY** be used in vehicles that have the lower anchor bars installed in designated seating positions. Most vehicles manufactured after September 2002 are equipped with lower anchor bars.

Check your vehicle owner's manual to see which seating positions may be equipped with LATCH: lower anchor bars.



**Do not use both the lower anchor belt and vehicle belt at the same time.**

**When used correctly the lower anchor belt or vehicle belts are equally safe.**

*continued on next page*



Lower Anchor Belt  
Storage Location

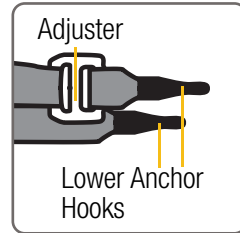

Adjuster  
Lower Anchor  
Hooks

### To Remove Lower Anchor Belt from Storage

**Location on Car Seat:** Squeeze spring lever on hooks and remove hooks from storage attachments.

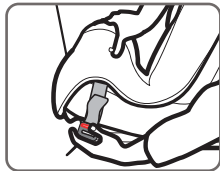

### To Remove Lower Anchor Belt from Vehicle Lower Anchor Bars:

Remove tension from the belt by pushing down on side of child restraint with the belt adjuster. Then press the adjuster button to loosen belt.

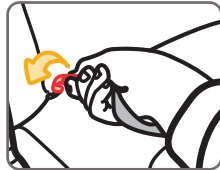

Unhook from anchor by squeezing spring lever on hook, pushing hook back into the seat bight, and twisting. Then pull it out of the vehicle seat.

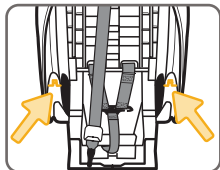

Lower Anchor Belt  
Storage Location

### To Store Lower Anchor Belt:

**When using vehicle belts, using the booster seat mode, or when the car seat is not installed in a vehicle,** the lower anchor belt must be properly stored in its storage location.

Thread lower anchor belt through rear-facing belt path then attach hooks to storage attachments as shown.

Gently tighten to remove slack.

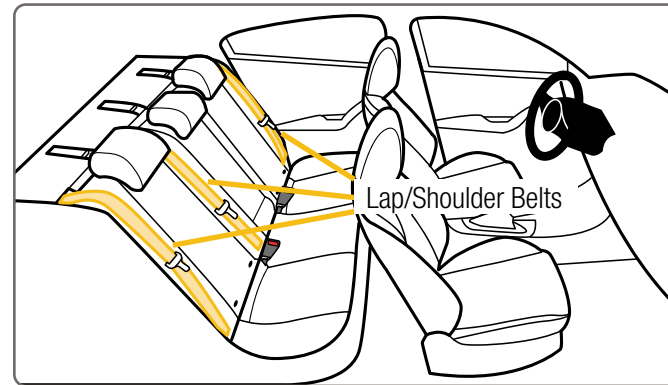

Your vehicle's features may be considerably different than those pictured here.

If lower anchors are not an option or if your child weighs more than 40 lb (18 kg), you must use the vehicle seat belt system to install the child restraint.

**Not all vehicle belts and seating positions will work with child restraints.**

Please go through the following steps to understand how to lock a child restraint in **Rear-Facing** or **Forward-Facing** mode with a vehicle belt.

*continued on next page*

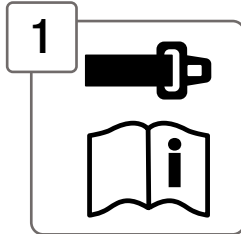

1

### You MUST Review Your Vehicle Owner's Manual

Your vehicle owner's manual will let you know which vehicle belts and seating positions child restraints can be installed in.

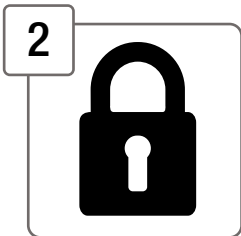

2

### Determine How the Child Restraint Will Be Locked Into Place

The vehicle belt **must not** loosen after tightening. This means there needs to be a way to lock the vehicle belt.

The ways this can be done are:

- By using the seat belt's retractor (see step 3); **OR**
- By using the seat belt's latch plate (see step 4).

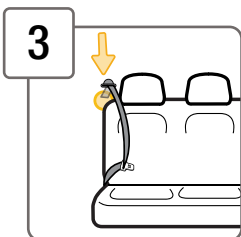

3

### Check the Retractor

Retractors pull seat belts into stored positions and lock the belt to hold passengers in place.

See the next page for some common types of vehicle belt retractors that will work with this child restraint.



## Types of Retractors

### Switchable Retractor (most vehicles have this type)



This retractor can be switched to a locking mode.

You **must have the retractor in the locking mode** to use the seat belt with this child restraint.

**Switching to locking mode:** Slowly pull the shoulder belt all the way out, then let it go back in an inch or two.

As it goes back in, you will most likely hear a ratcheting sound.

Gently pull the belt to see if it has locked. You will not be able to pull any more belt out if the lock has engaged.

### Automatic Locking Retractor



This retractor always locks.

It will automatically lock after slowly pulling the seat belt out at least halfway and letting the belt go back into the retractor an inch or two.

### Emergency Locking Retractor

See Step 4, "Check the Latch Plates".

If the retractor does not lock, it is most likely an Emergency Locking Retractor. These retractors only lock during a sudden stop or collision.

You will need to determine if your seat belt's latch plate can lock the belt. See Step 4, "Check the Latch Plates".

*continued on next page*



4

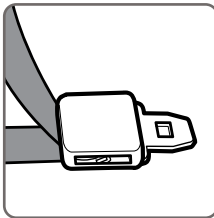

**Locking Latch Plate**

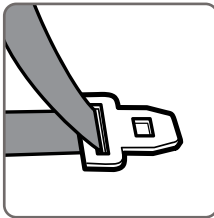

**Emergency Locking Retractor with a Sliding Latch Plate**

### Check the Latch Plates

Latch plates are the part of the seat belt that goes into the buckle.

To see if the latch plate locks:  
Buckle the vehicle belt.

Then firmly tug the lap portion of the seat belt while pulling it up.

If the vehicle belt does not slide through the latch plate, it's locked.

If the latch plate slides up and down the vehicle belt, it is a **sliding latch plate**.

Sliding latch plates easily slip between the lap and shoulder portions of the belt.

**If you have an Emergency Locking Retractor with a Sliding Latch Plate, you must use a locking clip.**

Please contact us for one.

See page 77.

### Never Use With This Child Restraint

Emergency Locking Retractor Lap Only Belt	✘
Inflatable Seat Belts	✘



### For Forward-Facing Mode Only

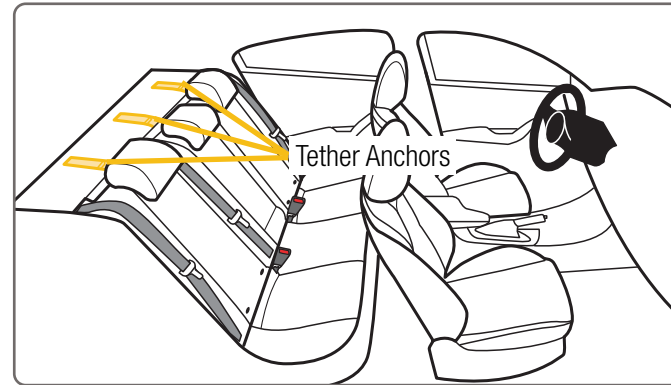

Your vehicle's features may be considerably different than those pictured here.

You **must always attach, adjust, and secure the top anchorage (tether) strap** when installing the child restraint forward-facing with internal harness. Tethers improve the installation and stability of child restraints and reduce the risk of injury.

Attach the tether hook to the tether anchor designated by your vehicle manufacturer for that seating position. Check your vehicle owner's manual for more information.

If the seating position does not have a tether anchor, use a different seating position or see your dealer or a qualified mechanic and have one installed.



**Using this child restraint without the tether strap anchored as recommended by the manufacturer would be a misuse of the child restraint and, in a sudden stop or crash, could result in serious injury or death.**

**Do not fasten multiple tether hooks on the same tether anchor in the vehicle.**

*continued on next page*



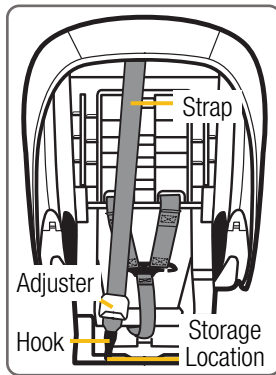

Tether Storage  
and Parts

### Storing Tether Strap

When installing rear-facing, using the booster seat mode, or when the car seat is not installed in a vehicle, attach the tether hook to its storage attachment on back of car seat as shown.

Gently tighten to remove slack.

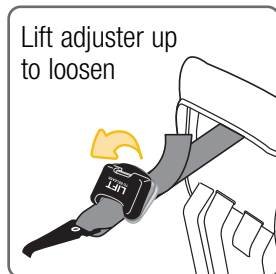
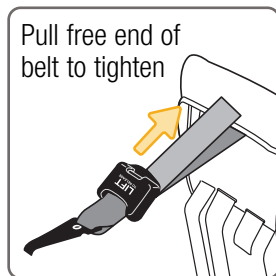

### Adjusting Tether Strap

**To tighten:** After the child restraint is locked into place with the lower anchor belt or vehicle belt, push down on child restraint and gently pull on free end of tether strap.

**To loosen:** Lift up on tether adjuster and push it towards tether hook.



5-40 lb (2.3-18 kg) and  
19-40 in. (48-101.6 cm)

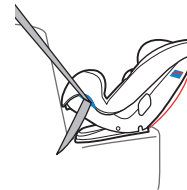

Lap/Shoulder  
Belt

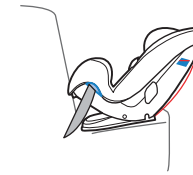

Lap Belt

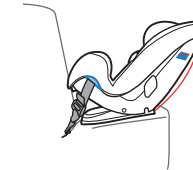

LATCH: Lower  
Anchor Belt



Never install a rear-facing child restraint in the front seat of a vehicle equipped with an active frontal airbag.

Do not use the tether for rear-facing mode. Secure tether strap to its storage location.

Do not use the lower anchor belt along with the vehicle lap or lap/shoulder belt.

Check the vehicle belt or the lower anchor belt before each use. Use only if the belt can be tightened properly and locked securely in place.

Do not fasten multiple lower anchor hooks on the same lower anchor bar in the vehicle.

Even when unoccupied, this child restraint must be firmly secured to the vehicle with a lower anchor belt or with the vehicle seat belt.

This child restraint **MUST** always face the rear of the vehicle until the child is at least 1 year old and weighs 22 lb (10 kg).



Before you begin installing the seat into your vehicle, did you check:



**Your child's weight and height?**  
See page 6.



**Your child's fit?** See page 9.  
Do you need to make adjustments to the harness/headrest height or the buckle position?

1

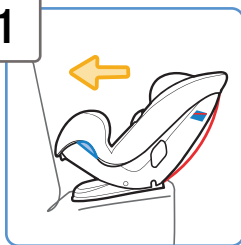

**Place Car Seat Rear-Facing in Back Seat**

2

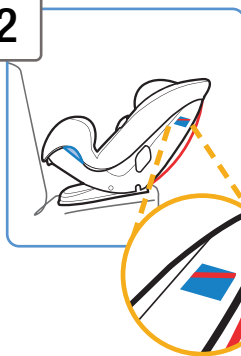

**Check Rear-Facing Level Line**

For children who cannot sit up unassisted, the level line **must** be parallel with the ground.

Recline the car seat to achieve the proper angle, see step 3.

For children who can sit up unassisted, you may rotate the child restraint to be more upright in Position 2.



3

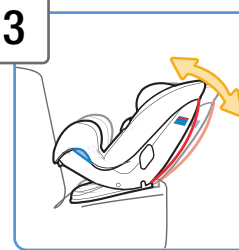

**Recline the Car Seat**

Pull out on recline handle and push top of child restraint back.

4

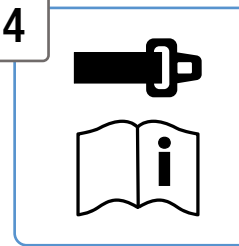

**Check if Your Vehicle Belts Will Work With This Child Restraint**

This is very important because **not all vehicle belts will work with child restraints.**

Review pages 22-25 and your vehicle owner's manual to determine what kind of vehicle belt you have and how to lock a child restraint in place.

5

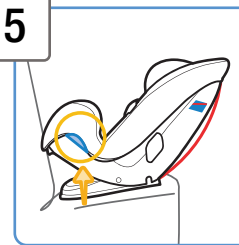

**Locate Rear-Facing Belt Path**

*continued on next page*

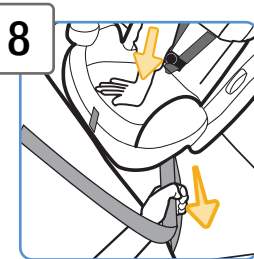
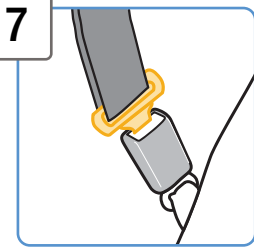
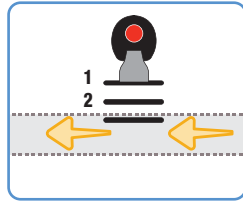
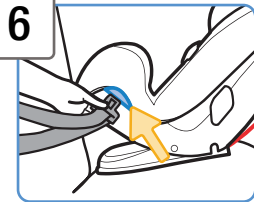

### Route the Vehicle Belt

Thread the vehicle belt into the **Rear-Facing Belt Path** opening.

Pull it across the seat, under the seat pad, in front of the buckle, and out through the other belt path opening.

**Do not twist belt.**

### Buckle the Vehicle Belt

If your car's vehicle belt has a switchable retractor, use it to lock the vehicle belt.

For information about switchable retractors, see page 24 or review your vehicle owner's manual.

### Tighten Belt

Place hand in child restraint.

Firmly push child restraint down and back towards the vehicle seat back while pulling the shoulder belt or the free end of lap belt parallel with the belt path through the belt path opening as shown.

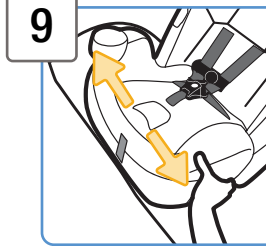

### Check Belt Tightness

Hold child restraint at the belt path with your weaker hand.

Push and pull from side to side.

It should not move more than **1 in. (2.5 cm)**.

**If it moves more than 1 in. (2.5 cm), you can try:**

- A. Pulling the belt tighter.
- B. Reinstalling the child restraint.
- C. Changing to a different seating location.
- D. Switching to lower anchor belt installation if lower anchors are available in your vehicle.

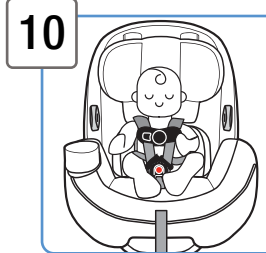

### Secure Child in Car Seat

To properly secure your child in the car seat, see pages 49-51.

Check your child's fit often and make any needed adjustments to the car seat as they grow.

*continued on next page*

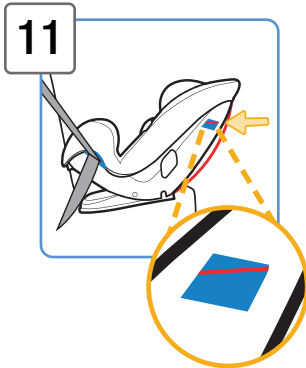

### Recheck Rear-Facing Level Line

Redo the installation if not reclined correctly for your child.

For children who cannot sit up unassisted, the level line must be parallel with the ground.

For children who can sit up unassisted, you may rotate the child restraint to be more upright in Position 2.

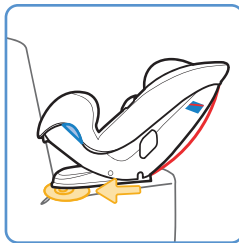

**NOTE:** Only if necessary, you may need to place a tightly rolled towel(s) or foam pool noodle(s) under the front of the base to help achieve the correct recline.

Check often to be sure padding is still in place and the belt is tight.

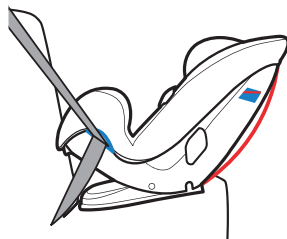

### Finished!

Check the tightness of the install often to make sure it has not loosened.

## Rear-Facing LATCH: Lower Anchor Install



Before you begin installing the seat into your vehicle, did you check:

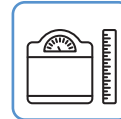

Your child's weight and height?  
See page 6.



Your child's fit? See page 9.

Do you need to make adjustments to the harness/headrest height or the buckle position?

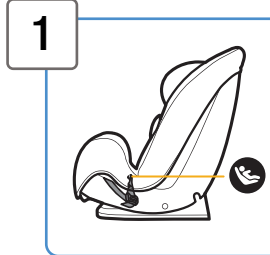

### 1 Remove Lower Anchor Belt from Storage Location

Or if the lower anchor belt was used Forward-Facing, remove it from the Forward-Facing belt path so both hooks are on the same side of the seat.

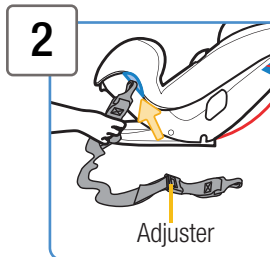

### 2 Locate Rear-Facing Belt Path

Route the lower anchor belt through the **Rear-Facing Belt Path** opening as shown. The lower anchor belt adjuster can be on either side.

*continued on next page*



3

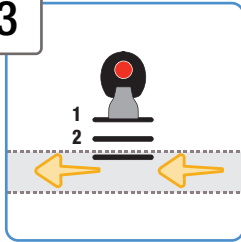

### Pull Lower Anchor Belt Across the Seat

It must be under the seat pad, in front of the buckle, and go out through the other belt path opening.

**Do not twist belt.**

4



### Finished Lower Anchor Belt Routing

5

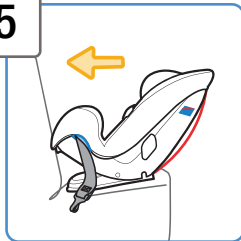

### Place Car Seat Rear-Facing in Back Seat

6

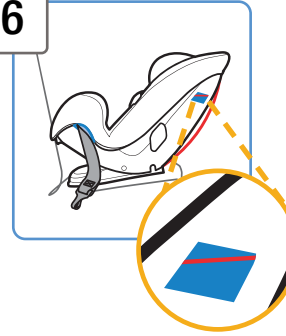

### Check Rear-Facing Level Line

For children who cannot sit up unassisted, the level line **must** be parallel with the ground.

Recline the car seat to achieve the proper angle, see step 7.

For children who can sit up unassisted, you may rotate the child restraint to be more upright in Position 2.

7

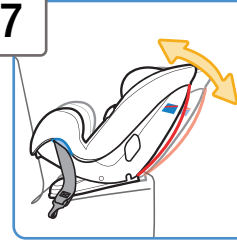

### Recline the Car Seat

Pull out on recline handle and push top of child restraint back.

8

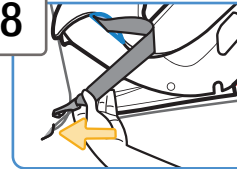

### Attach Lower Anchor Hooks to Vehicle's Lower Anchors

Review your vehicle owner's manual for lower anchor locations and lower anchor belt use.

**Repeat for other side of child restraint.**

*continued on next page*





9

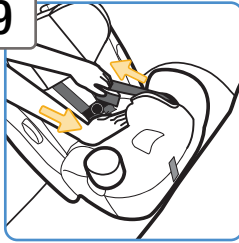

### Tighten Belt

Place hand in child restraint.

Firmly push child restraint down and towards the vehicle seat back while pulling the free end of the belt parallel with the belt path through the belt path opening as shown.

10

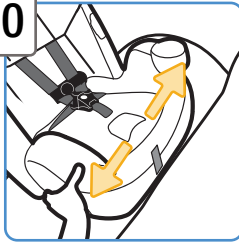

### Check Belt Tightness

Hold child restraint at the belt path with your weaker hand.

Push and pull from side to side.

It should not move more than **1 in. (2.5 cm)**.

**If it moves more than 1 in. (2.5 cm), you can try:**

- A. Pulling the belt tighter.
- B. Reinstalling the child restraint.
- C. Changing to a different seating location.
- D. Switching to vehicle belt installation.

11



### Secure Child in Car Seat

To properly secure your child in the car seat, see pages 49-51.

Check your child's fit often and make any needed adjustments to the car seat as they grow.



12

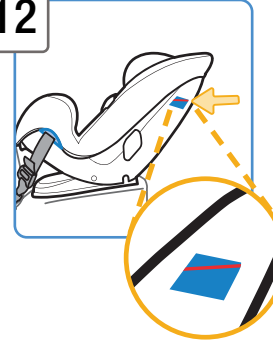

### Recheck Rear-Facing Level Line

For children who cannot sit up **unassisted**, the level line **must** be parallel with the ground.

For children who can sit up **unassisted**, you may rotate the child restraint to be more upright in Position 2.

**Redo the installation if not reclined correctly for your child.**

**NOTE:** Only if necessary, you may need to place a tightly rolled towel(s) or foam pool noodle(s) under the front of the base to help achieve the correct recline.

Check often to be sure padding is still in place and the belt is tight.

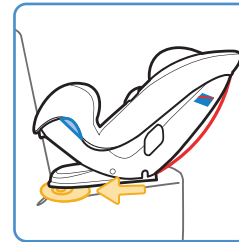

### Finished!

Check the tightness of the install often to make sure it has not loosened.

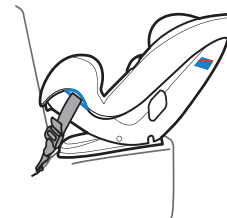



## Forward-Facing Mode

**22-50 lb (10.1-22.6 kg) and  
29-45 in. (73.6-114.3 cm)  
and at least 1 year old**

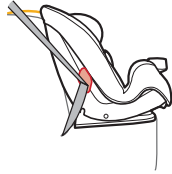

**Lap/Shoulder  
Belt and Tether**

up to 50 lb  
(22.6 kg)

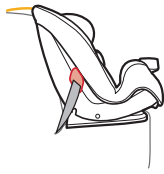

**Lap Belt  
and Tether**

up to 50 lb  
(22.6 kg)

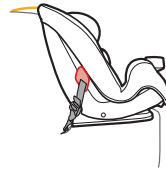

**LATCH: Lower Anchor  
Belt and Tether**

Do not install by this  
method for a child  
weighing more than  
40 lbs (18 kg).



Do not use the lower anchor belt along with the vehicle lap or lap/shoulder belt.

Check the vehicle belt or the lower anchor belt before each use. Use only if the belt can be tightened properly and locked securely in place.

Do not fasten multiple lower anchor hooks on the same lower anchor bar in the vehicle.

Even when unoccupied, this child restraint must be firmly secured to the vehicle with a lower anchor belt or with the vehicle seat belt.

In this child restraint your child **MUST** be at least 1 year old and weigh 22 lb (10 kg) before they sit forward-facing.

## Forward-Facing Vehicle Belt + Tether Install



**Before you begin installing the seat  
into your vehicle, did you check:**

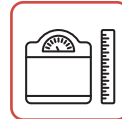

**Your child's weight and height?**  
See page 39.



**Your child's fit? See page 10.**

Do you need to make adjustments to the  
harness/headrest height or the buckle position?

1

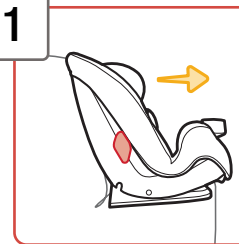

**Place Car Seat Forward-  
Facing in Back Seat**

2

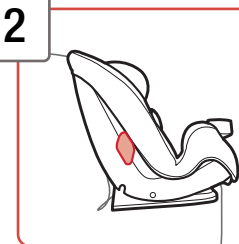

**Make Car Seat Flush  
Against Vehicle Seat**

Put the child restraint into  
Position 1.

Do not use any recline positions  
except to make the child restraint  
flush against the vehicle seat back.

Vehicle seat back must be upright.

*continued on next page*

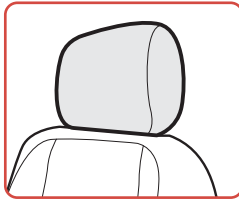

**NOTE:** If your vehicle seat has a headrest that interferes with achieving a flush car seat fit, check your vehicle owner's manual to see if it can be removed, adjusted, or if there are other possible seating locations.

3

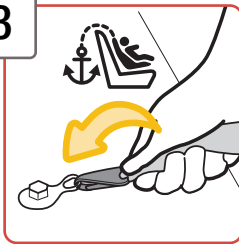

### Loosely Attach Tether Hook to Vehicle's Tether Anchor

Check vehicle owner's manual for specific location.

4

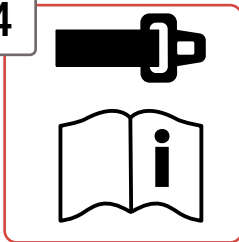

### Check if Your Vehicle Belts Will Work With This Child Restraint

This is very important because **not all vehicle belts will work with child restraints.**

Review pages 22-25 and your vehicle owner's manual to determine what kind of vehicle belt you have and how to lock a child restraint in place.



5

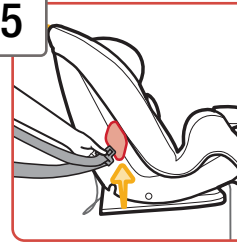

### Route the Vehicle Belt

Thread the vehicle belt through **Forward-Facing Belt Path** opening.

Pull it across the seat. Then thread it through the other belt path opening.

**Do not twist belt.**

6

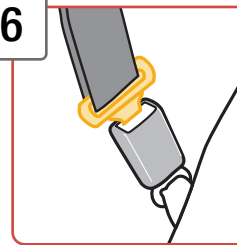

### Buckle the Vehicle Belt

If your car's vehicle belt has a switchable retractor, use it to lock the vehicle belt.

For information about switchable retractors, see page 24 or review your vehicle owner's manual.

7

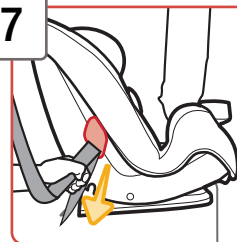

### Tighten Belt

Place hand in child restraint.

Firmly push child restraint down while pulling the shoulder belt or free end of the lap belt parallel with the belt path through the belt path opening as shown.

8

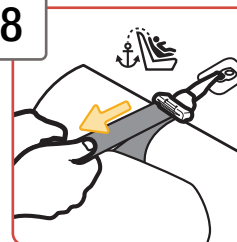

### Tighten Tether

Push firmly on the back of the seat and pull the tether strap to remove all slack and create tension on the strap.

*continued on next page*



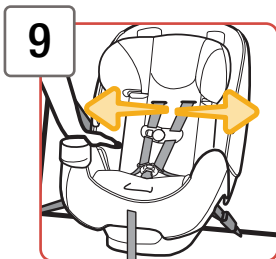

### Check Belt Tightness

Hold child restraint at the belt path with your weaker hand. Push and pull from side to side. It should not move more than **1 in. (2.5 cm)**.

If it moves more than 1 in. (2.5 cm), you can try:

- A. Putting your knee in the seat and pulling the belt tighter.
- B. Reinstalling the child restraint.
- C. Changing to a different seating location.
- D. Switching to the lower anchor belt installation if lower anchors are available in your vehicle.

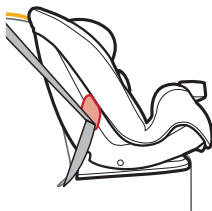

### Finished!

Check the tightness of the install often to make sure it has not loosened.



### Securing Child in Car Seat

To properly secure your child in the car seat, see pages 49-51.

Check your child's fit often and make any needed adjustments to the car seat as they grow.

## Forward-Facing LATCH: Lower Anchor + Tether Install



Before you begin installing the seat into your vehicle, did you check:



**Your child's weight and height?**  
See page 39.



**Your child's fit? See page 10.**

Do you need to make adjustments to the harness/headrest height or the buckle position?

**⚠ Do not use the lower anchors of the child restraint anchorage system (LATCH system) to attach this child restraint when restraining a child weighing more than 40 lbs (18 kg).**

1

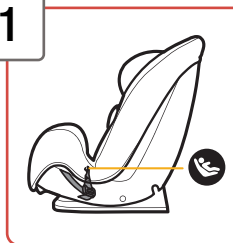

### Remove Lower Anchor Belt from Storage Location

Remove it from the rear-facing belt path so both hooks are on the same side of the seat.

*continued on next page*

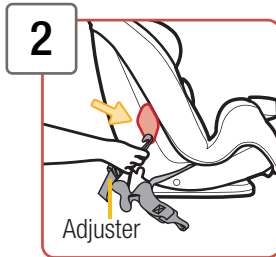

### 2 Route the Lower Anchor Belt Through Forward-Facing Belt Path As Shown

The lower anchor belt adjuster can be on either side.

**Do not twist belt.**

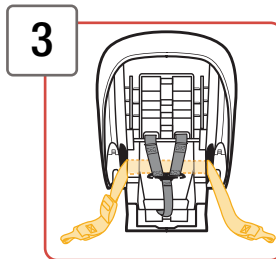

### 3 Finished Lower Anchor Belt Routing

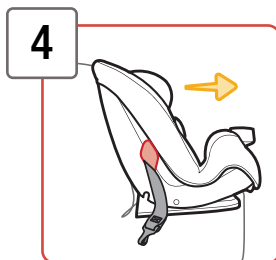

### 4 Place Car Seat Forward-Facing in Back Seat

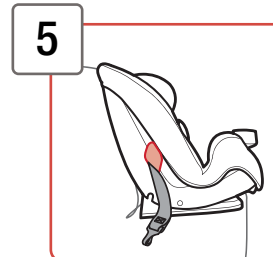

### 5 Make Car Seat Flush Against Vehicle Seat

Put the child restraint into Position 1.

Do not use any recline positions except to make the child restraint flush against the vehicle seat back.

Vehicle seat back must be upright.

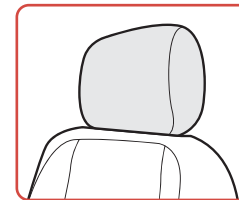

**NOTE: If your vehicle seat has a headrest that interferes with achieving a flush car seat fit, check your vehicle owner's manual to see if it can be removed, adjusted, or if there are other possible seating locations.**

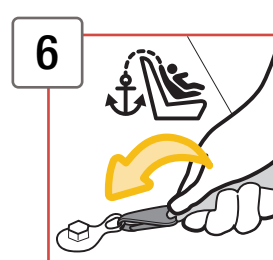

### 6 Loosely Attach Tether Hook to Vehicle's Tether Anchor

Check vehicle owner's manual for specific location.

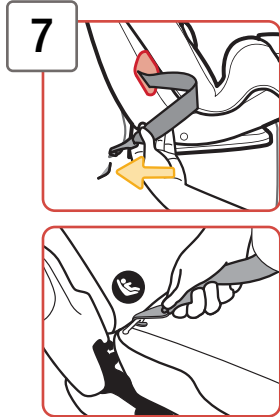

### 7 Attach Lower Anchor Hooks to Vehicle's Lower Anchors

Review your vehicle owner's manual for lower anchor locations and lower anchor belt use.

**Repeat for other side of child restraint.**

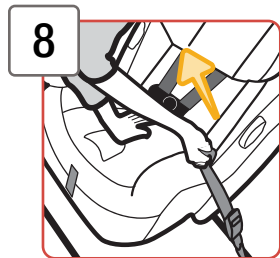

8

### Tighten Belt

Place hand in child restraint.

Firmly push child restraint down while pulling the free end of the belt parallel with the belt path through the belt path opening as shown.

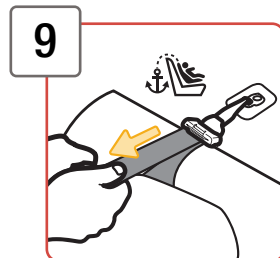

9

### Tighten Tether

Push firmly on the back of the seat and pull the tether strap to remove all slack and create tension on the strap.

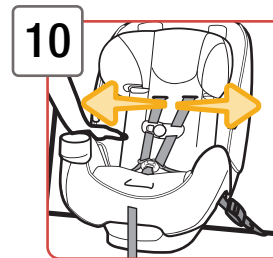

10

### Check Belt Tightness

Hold child restraint at the belt path with your weaker hand.

Push and pull from side to side.

It should not move more than **1 in. (2.5 cm)**.

**If it moves more than 1 in. (2.5 cm), you can try:**

- A. Putting your knee in the seat and pulling the belt tighter.
- B. Reinstalling the child restraint.
- C. Changing to a different seating location.
- D. Switching to vehicle belt installation.

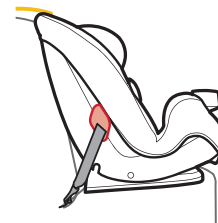

### Finished!

Check the tightness of the install often to make sure it has not loosened.



### Securing Child in Car Seat

To properly secure your child in the car seat, see pages 49-51.

Check your child's fit often and make any needed adjustments to the car seat as they grow.

1

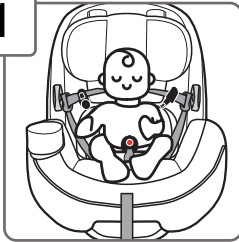
**Place Child in Car Seat**

The child's bottom and back should be flat against the car seat.

Position harness straps over your child's shoulders and upper thighs.

2

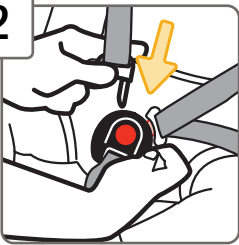
**Buckle Harness**

Push buckle tongues into buckle until you hear them "click".

Pull up on harness straps to make sure buckle is locked.

3

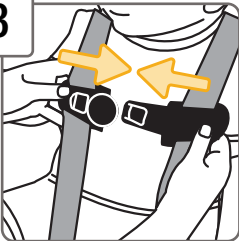
**Fasten Chest Clip**

Insert right half of chest clip into left half and snap together.

4

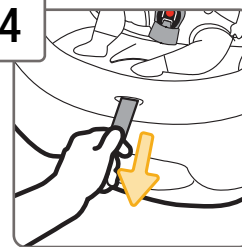
**Tighten Harness**

Pull on harness adjustment strap to snugly tighten harness.

5

**Position Chest Clip**

Slide chest clip up the harness straps and position it at mid-chest (even with armpits) and away from the child's neck.

6

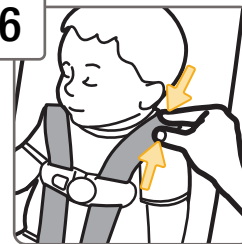
**Check Harness Tightness**

Try to pinch the harness at the shoulders and hips vertically between index finger and thumb as shown.

**If your fingers slip off**, the harness is tight enough.

**If you can pinch the harness strap**, tighten more.

A snug strap should not allow any slack. It lies in a relatively straight line without sagging. It does not press on the child's flesh or push the child's body into an unnatural position.



## Finished!

The child is now secured in the car seat.

Check your child's fit often and make any needed adjustments to the car seat as they grow.

### To Remove Child from Car Seat:

1. Loosen Harness Strap
2. Unbuckle Harness
3. Release Chest Clip
4. Remove Child



Failure to fasten and tighten the harness system correctly may allow the child to be ejected from the child restraint in a crash or sudden stop causing serious injury or death.



Do not mistake comfort for safety. Harness system must be snugly adjusted.

Do not put snowsuits or bulky garments on your child when placing them in the child restraint. Bulky clothing can prevent the harness straps from being tightened properly.



**40-80 lb (18.1-36.3 kg) and  
43-52 in. (110.1-132.1 cm)**



Lap/Shoulder  
Belt

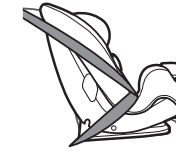

Keep the booster seat  
securely belted even  
when unoccupied.



Do not use the harness system when using as a booster seat.



Use only the vehicle's lap and shoulder belt system when restraining the child in this booster seat. Do not use only the lap belt when using this seat as a booster seat.

The shoulder belt must always be adjusted snugly across the child's chest. NEVER place shoulder belt under the child's arms or behind their back.

Do not use this booster seat if the tops of your child's ears are above the top of the booster seat's headrest.

Do not use LATCH when using as a booster seat. Secure lower anchor belt and tether strap to their storage locations.

You must store the harness system and remove accessories when using the Booster Seat mode.

To remove accessories, see page 4.

**⚠** Do not fully pull the harness strap out of the car seat. Leave it threaded in the hip harness slots. If removed, you will not be able to rethread it.

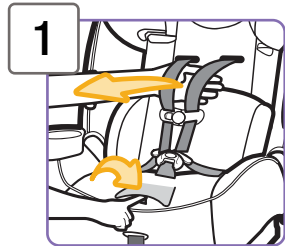

### 1 Fully Loosen Harness Straps

Push down on harness release lever (through opening in pad) while pulling out on harness straps as shown.

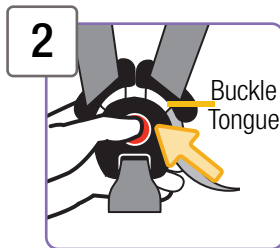

### 2 Unbuckle Harness

Press in towards the **top** of the red button to release the buckle tongues.

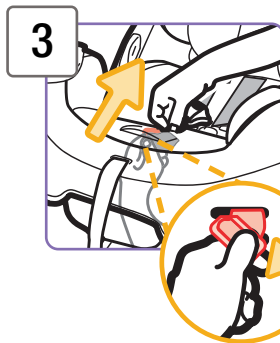

### 3 Locate Buckle's Metal Retainer

Fully recline the child restraint and reach under the seat between the base and shell and through the recline handle.

Rotate metal retainer and push it up through shell and pad.

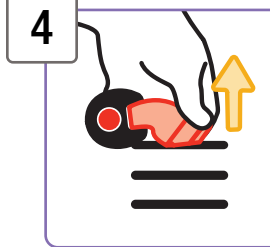

### 4 From Top of Seat, Pull Buckle Out of Shell and Pad

Store the buckle in a safe place for future use.

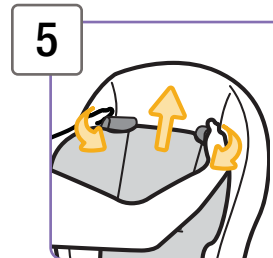

### 5 Adjust Headrest to Highest Position

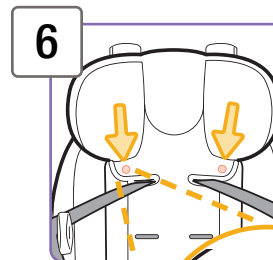

### 6 Undo Fasteners on Headrest Pad As Shown

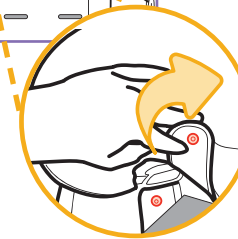

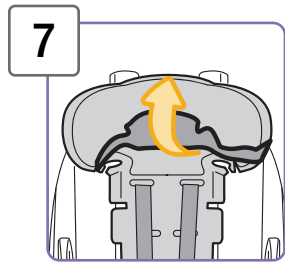

**7** Pull Headrest Pad Off Bottom of Headrest As Shown

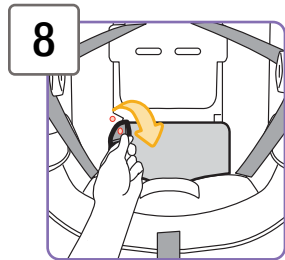

**8** Undo Fasteners on Seat Pad As Shown

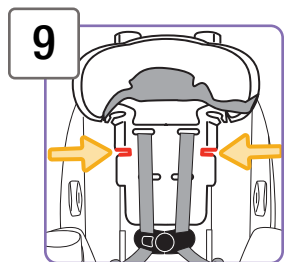

**9** Thread Harness Straps into Slots on Sides of Headrest As Shown

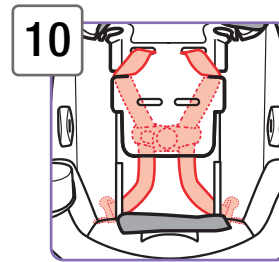
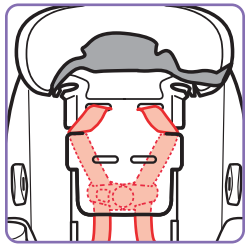

**10** Place Chest Clip, Harness Straps, and Buckle Tongues Behind the Headrest and Seat Pad As Shown

Push chest clip up so it is behind the headrest.

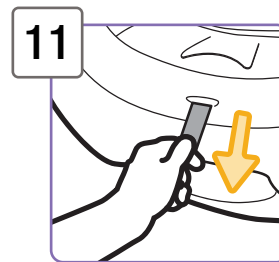

**11** Tighten Harness

Pull on harness adjustment strap to remove any slack from the harness system.

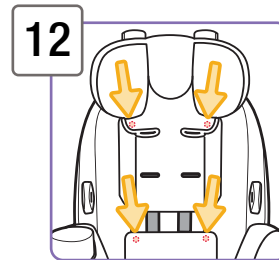

**12** Pull Headrest Pad Down and Wrap Around Bottom of Headrest

Attach fasteners on seat pad.

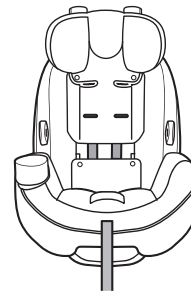

**Finished!**

The car seat has been converted to **Booster Seat Mode**.

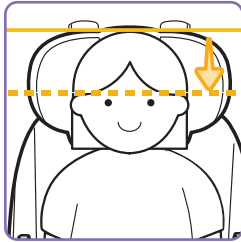

### Head Position

Tops of the child's ears should never be above the top of the headrest.

Adjust headrest if needed, see page 11.



### Shoulder Belt Position

The shoulder belt should lay snugly across the center of the child's shoulder and across the chest and not on their face or neck.

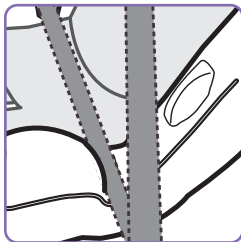

### Lap Belt Position

The lap belt should lay snugly across the child's hips and not on their stomach.



You must store the harness system when using the **Booster Seat mode**. See pages 53-56.

1

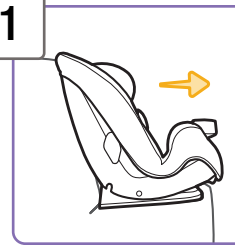

### Place Booster Seat Forward-Facing in Back Seat

Put the booster seat into Position 1.

Do not use any recline positions except to make the booster seat flush against the vehicle seat back.

Vehicle seat back must be upright.

**NOTE:** If your vehicle seat has a headrest that interferes with achieving a flush car seat fit, check your vehicle owner's manual to see if it can be removed, adjusted, or if there are other possible seating locations.

2



### Have Child Sit in Booster Seat

3

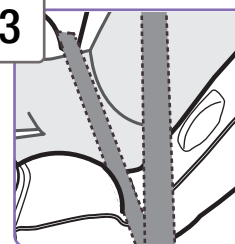

### Position Lap Belt on Child

Route the lap belt portion of vehicle belt through the booster belt path as shown.

The lap belt should lay snugly across the child's hips and not on the stomach.

*continued on next page*





4

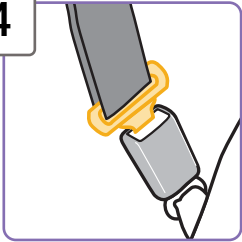

### Buckle the Vehicle Belt

Pull up on lap belt to tighten.

5



### Position Shoulder Belt on Child

Pull up on shoulder belt to tighten.

The shoulder belt should lay under the In and Out Harness Holder as shown.

The shoulder belt should lay snugly across the center of the child's shoulder and across the chest and not on their face or neck.

Only use the shoulder belt-positioning guide in the headrest if necessary to help position the shoulder belt correctly on the child.

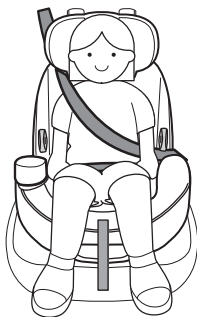
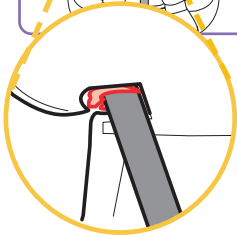

### Finished!

Check periodically to make sure your child has not moved out of position and loosened the shoulder belt.

## Removing Seat Pad Set for Cleaning

You **DO NOT** need to remove the harness system to remove the pad from the shell.

To remove accessories, see page 4.

1

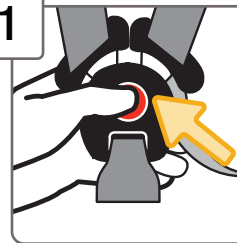

### Unbuckle Harness

Press in towards the **top** of the red button.

Pull buckle tongues out.

2

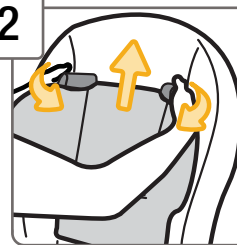

### Adjust Headrest to Highest Position

3

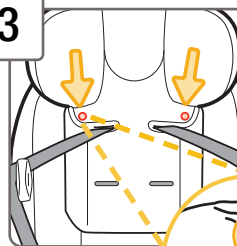

### Undo Fasteners on Headrest Pad As Shown



*continued on next page*

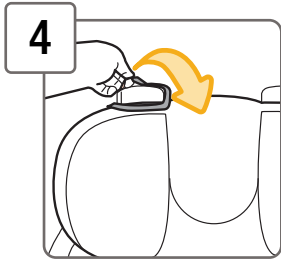

**4** Pull Elastic Straps on Headrest Pad Over Headrest/Harness Adjustment Levers As Shown

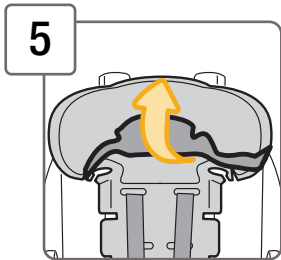

**5** Pull Headrest Pad Off Bottom of Headrest As Shown

Remove headrest pad from shell.

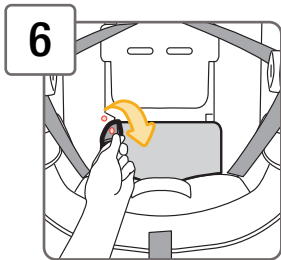

**6** Undo Fasteners on Seat Pad As Shown

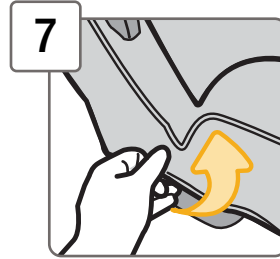

**7** Pull Pad Off Sides and Bottom of Shell

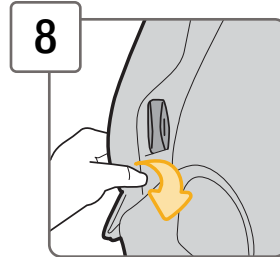
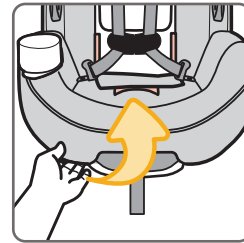

**8** Pull Pad Down and Off of Bottom of Harness Holders (on select models)

Pull up to remove completely.

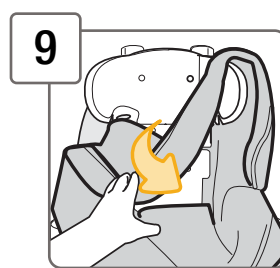

**9** From Top of Seat, Pull Pad Off of Shell

## Cleaning Parts of Car Seat and Installing Seat Pad Set

### Cleaning Pad and Accessories

Machine wash separately with cold water on a gentle cycle. Do not use bleach. Tumble dry separately for 10-12 minutes on low heat. Remove immediately.

### Cleaning Harness Strap

Check the harness straps often for any wear or damage.

**⚠ Do not fully pull the harness strap out of the car seat. Leave it threaded in the hip harness slots. If removed, you will not be able to rethread it.**

Spot clean using warm sudsy water and damp cloth. Spilled food and liquids on the car seat may result in mold or bacterial growth over time. These spills could also attract insects or rodents.

### Cleaning Buckle & Car Seat Shell

Spot clean using warm sudsy water and damp cloth. Do not submerge into water.

**⚠ Do not use the child restraint without the seat pad or with damaged harness straps.**

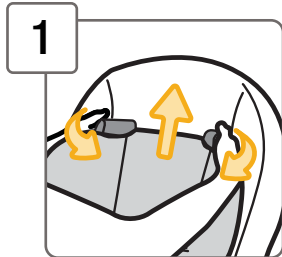

**1** Adjust Headrest to Highest Position

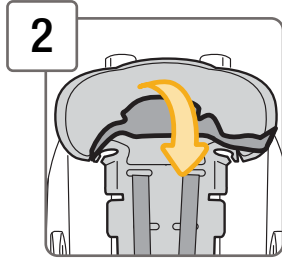

**2** Gently Pull Headrest Pad onto Headrest

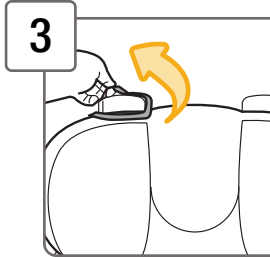

**3** Place Elastic Straps on Headrest Pad Around Headrest/Harness Adjustment Levers

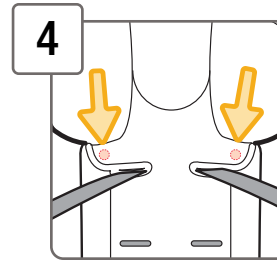

**4** Slide Harness Straps Into Slots in Pad and Attach Fasteners

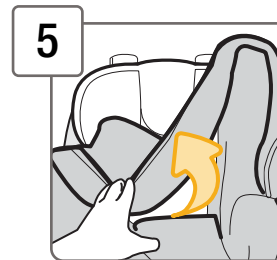

**5** Starting from Bottom of Car Seat, Slip Pad on Shell

*continued on next page*

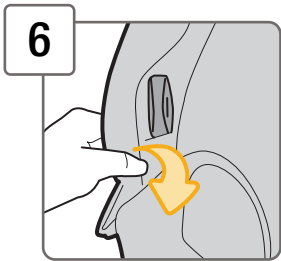

**6** Push In and Out Harness Holders Through Slots in Pad (on select models)

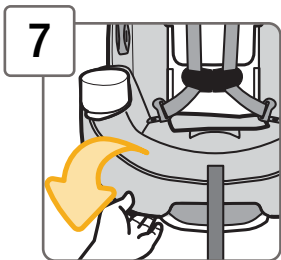

**7** Wrap Pad Around Bottom and Sides of Shell

Pull harness adjustment strap and buckle through the slots in pad.

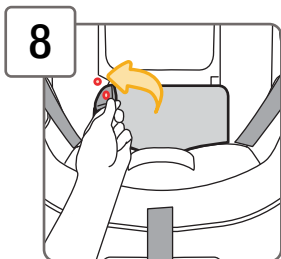
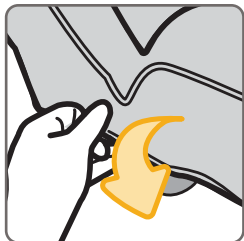

**8** Attach Seat Pad Fasteners As Shown

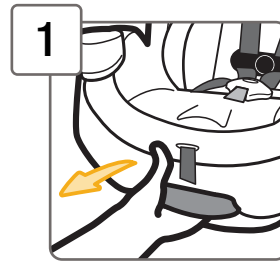

**1** Fully Recline the Car Seat

Pull out on recline handle and push top of child restraint back.

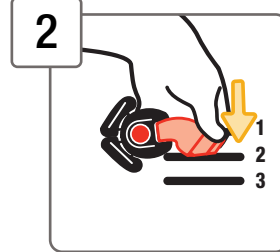

**2** Insert Buckle's Metal Retainer into Slot Closest to Child

Buckle **must** face out.

**Rear-Facing Mode:** You **must** use the 1st or 2nd buckle slots.

**Forward-Facing Mode:** Any slot can be used.

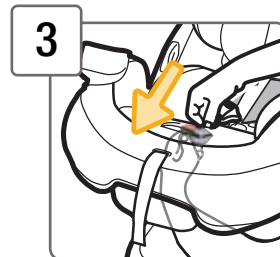

**3** Reach Under Seat Between Base and Shell and Through Recline Handle

Pull metal retainer completely through pad and shell.

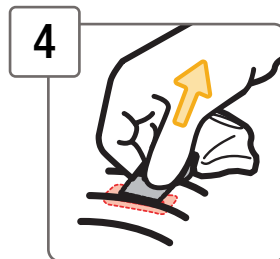

**4** Check Buckle

Pull up on buckle to make sure it is secured.

The buckle **must** not pull out.

*continued on next page*

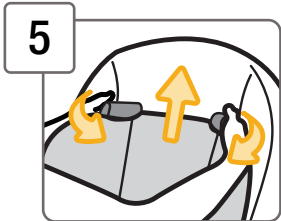

**Adjust Headrest to Highest Position**

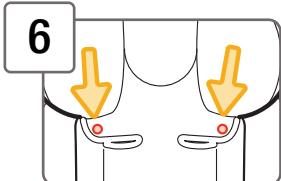

**Undo Fasteners on Headrest Pad and Seat Pad and Pull Headrest Pad Off Bottom of Headrest**

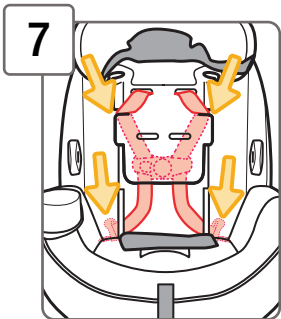
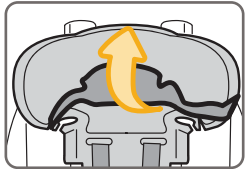

**Unthread Harness Straps From Slots on Side of Headrest**

Loosen harness straps.

Pull chest clip, harness straps, and buckle tongues out from behind the headrest and seat pad.

Slide harness straps into slots in headrest pad.

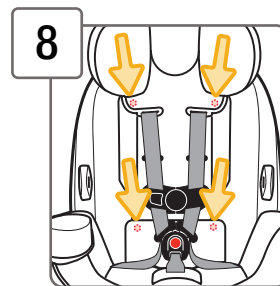

**Attach Seat Pad Fasteners**

If you have removed the harness straps from the splitter plate, and the buckle tongues and chest clip have been unthreaded from the harness straps, follow the steps below to rethread them.

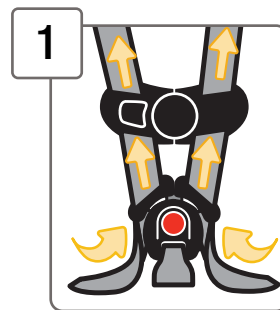

**Thread Buckle and Chest Clip**

Harness strap ends go through the **back** of buckle tongues and through the chest clip **front to back** as shown.

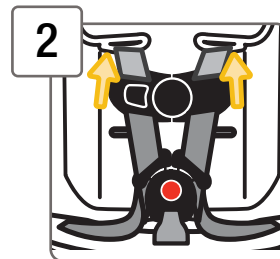

**Thread Harness Straps into Upper Shoulder Harness Slots**

If you will be using the lower shoulder harness slots for smaller children, see pages 15-18.

*continued on next page*

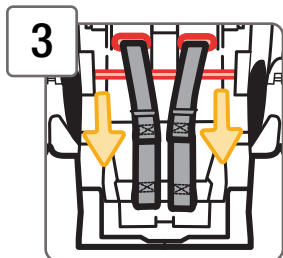

### 3 From Back, Thread Harness Straps OVER Metal Bar

Do not twist harness straps.

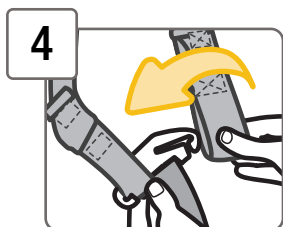

### 4 Attach 1st Harness Strap Loops to Splitter Plate As Shown

Sewn ends of the harness strap loops **must** face towards you.

**Do not** twist harness strap or harness adjustment strap.

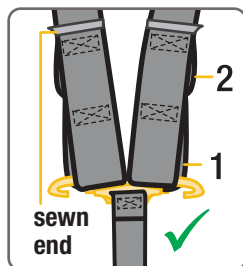

Make sure the same harness strap loops are fitted **completely** on both sides of the splitter plate.

Check your child's fit often.

If you cannot achieve a snug harness fit for your child, see pages 15-18.

To learn how to check harness tightness, see pages 49-51.

Check the harness straps often for any wear or damage.

**⚠** The harness system must be installed correctly. Do not use a child restraint with damaged harness straps.



This restraint is certified for aircraft use when used with the internal harness.

This child restraint is not certified for aircraft use when used as a booster seat because aircraft seats do not have shoulder belts.

Install the child restraint in a window seat to avoid blocking the aisle. If the aircraft lap belt is too short, ask the flight attendant for a belt extender.

Use only on forward-facing aircraft seats.

Contact the airline for their specific policies.



Some airlines may ask to see a label stating that this child restraint is certified for aircraft use.

There is an airplane certification label located on the side of this child restraint as shown.

**⚠** Store the lower anchor belt and tether strap when installing with aircraft belts.



### Rear-Facing Aircraft Installation

Follow the steps on pages 29-33.



### Forward-Facing Aircraft Installation

Follow the steps on pages 40-43, skipping the tether strap steps.

## Replacement and Expiration of Car Seat

### Do not risk your child's safety.

To keep your child as safe as possible, Dorel Juvenile Group strongly recommends replacing the car seat even after a minor crash; even if it was not occupied at the time.

### Replacement After a Minor Crash

The National Highway Traffic Safety Administration states that for a crash to be considered minor **ALL of the following must be true:**

- Vehicle able to drive away from the crash site; **AND**
- Vehicle door nearest the car seat was not damaged; **AND**
- No passengers were injured; **AND**
- Airbags did not deploy; **AND**
- There is no visible damage to the car seat.

If the crash your car seat was involved in meets **ALL** the criteria, you may not need to replace the car seat.

If one or more of these criteria are not true or if you are uncertain of any of your answers, replace the car seat immediately.

### Replacement After a Moderate to Severe Crash

You **must** replace this car seat if it has been in a moderate to severe car crash.

This car seat is intended to protect a child in a single crash. During a crash, the car seat and all of its parts absorb crash energy which can deform or weaken it. Damage is not always visible. A damaged car seat must be replaced immediately.

### Expiration



On the side of the child restraint there is a date of manufacture label as shown.

Do not use this child restraint more than 10 years after the date of manufacture.



### ⚠ Child Restraint Use

**Never take your child out of the child restraint while the vehicle is moving.**

**Never leave child unattended.** Placing your child in a hot child restraint may result in burns.

**Do not use a child restraint with damaged or missing parts.**

**Do not use a child restraint with cut, frayed or damaged harnesses.**

**Do not substitute parts or try to modify the child restraint in any way. Do not lubricate buckles and fasteners.**

**Do not use any child restraint accessory except those approved by Dorel Juvenile Group.**

**Never allow any child to play with this child restraint; it is not a toy.**

**Do not remove or cover up any of the warning labels or other labels on the child restraint.**

**This child restraint has been certified for use in passenger vehicles. Do not use in a boat, on a motorcycle or in a cargo van or bus where there are no seat belts or tether anchors.**

**Read all instructions for additional warnings.**

### ⚠ Installation in Vehicle

**Even when unoccupied, this child restraint must be firmly secured to the vehicle with a lower anchor belt or with the vehicle seat belt.**

**Even when unoccupied, this booster seat must be firmly secured to the vehicle with the vehicle seat belt.**

**In a crash or sudden stop, an unsecured child restraint or booster seat could injure occupants.**



### Vehicle Seating Position



**Never place a child rear-facing in a seating position with an active frontal air bag.**

**Check the vehicle owner's manual for more information about air bag/child restraint use.**



**Use the child restraint only on vehicle seats that face forward.**



**Do not use on seats that face the sides or rear of the vehicle.**

**For vehicles without a back seat, refer to your vehicle owner's manual.**



**Children are safer when properly restrained in rear seating positions than in the front seating positions.**

**According to accident statistics, children in rear seating positions are statistically safer, whether you have air bags, advanced air bags, or no air bags at all.**

**If you are not sure where to place the child restraint in your vehicle:** consult your vehicle owner's manual or contact Dorel Juvenile Group Consumer Care Department.

**To avoid your child being seriously burned, take the following precautions:**

1. Park in the shade or where sun does not directly hit the child restraint.
2. Cover the child restraint with a sheet or blanket when not in use.
3. Check for hot seat and buckles before placing child in child restraint.

To help protect your vehicle seat's upholstery from damage, use a single layer towel underneath and behind child restraint.



Please complete the postage-paid registration card that came with your child restraint, and send it to us. Child restraints could be recalled for safety reasons. You must register this restraint to be reached in a recall. Send your name, address, e-mail address if available and the restraint's model number and manufacturing date to:

**Dorel Juvenile Group, Inc.**  
2525 State Street  
Columbus, IN 47201

or call 1-800-544-1108 or register online at [www.djgusa.com/registration/carseat/us](http://www.djgusa.com/registration/carseat/us).

For recall information, call the U.S. Government's Vehicle Safety Hotline at 1-888-327-4236 (TTY: 1-800-424-9153), or go to <http://www.NHTSA.gov>.

Tear Off and Mail This Part or Register Online / Détachez et postez cette partie ou enregistrez en ligne 4359-4117E

**Consumer:** Just fill in your name, address and email. Please print.  
**Client:** Simplement inscrire votre nom, adresse et courriel. S.V.P. imprimez.

Your Name/ Votre nom: \_\_\_\_\_

Your Street Address/ Votre adresse: \_\_\_\_\_

City/ Ville: \_\_\_\_\_ Province: \_\_\_\_\_ Postal Code/ Code Postal: \_\_\_\_\_

Email Address (optional)/ Courriel (optionnel): \_\_\_\_\_

AB123CDE      SF CARSEAT      2015/05/16

Date of Purchase/ Date d'achat: \_\_\_\_\_ L#11 B265035

**Example of model number, line code and manufacture date.**

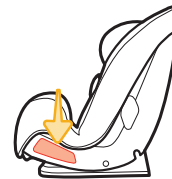

If you don't have the card or if your address changes, you will find the model number, manufacture date, and line code on the label located on side of shell.



Dorel Juvenile Group, Inc. (DJG) warrants this product to the original retail purchaser as follows: This product is warranted against defective materials or workmanship for one year from the date of original purchase.

**An original receipt is required to validate your warranty.**

DJG will, at its option, provide replacement parts or replace this product. DJG reserves the right to substitute if the part or model has been discontinued.

To make a claim under this warranty, please contact our Consumer Care Department by phone: 1-800-544-1108 or text: 1-812-652-2525. Our hours of operation are from 8:00 a.m. to 6:00 p.m. EST Monday through Thursday and from 8:00 a.m. to 4:30 p.m. on Friday.

**Proof of purchase is required and shipping charges are the responsibility of the consumer.**

**Warranty Limitations:** This warranty does not include damages which arise from misuse or abuse of this product.

**Limitation of Damages:** The warranty and remedies as set forth are exclusive and in lieu of all others, oral or written, expressed or implied. In no event will DJG or the dealer selling this product be liable to you for any damages, including incidental or consequential damages, arising out of the use or inability to use this product.

**Limitation of warranties and other warranty terms and state law rights:** Any implied warranties, including implied warranties of the merchantability and fitness for a particular purpose, shall be limited to the duration and terms of the express written warranty.

Some states do not allow limitations as to how long an implied warranty lasts or the exclusion or limitation of incidental or consequential damages, so the above limitations may not apply to you.

This warranty gives you specific legal rights, and you may have other rights, which vary from state to state. Neither DJG nor the dealer selling this product authorized any person to create for it any other warranty, obligation, or liability in connection with this product.

**1. If the child restraint buckle or harness release lever sticks or you cannot get the straps tight enough around child:**

**DO NOT LUBRICATE.** Check around lever and retractor for dropped food, sticky spilled drinks, dirt, leaves, etc. Clean with warm water and/or remove object with tweezers. If you cannot get the harness to adjust and remain tight with the buckle securely locked, do not use the child restraint.

**2. If your harness twists:**

Straighten the harness each time you put your child in the child restraint to help prevent twisting. Lock the buckle and tighten harness so it will be ready for next use.

Chest Clip	Lower Anchor Belt
Buckle Assembly	Instructions
Seat Pad Set	Locking Clip
Tether	

**If requested color is not available,  
similar color will be substituted.**

**Applicable tax and shipping &  
handling will also be added.**

**For parts availability and questions,**

**Call:** 1-800-544-1108

**Text:** 1-812-652-2525

**Chat:** [www.safety1st.com](http://www.safety1st.com)

**If you already know which parts you need,**  
you may complete your order with a credit card  
by calling us at 1-800-544-1108.

**We accept Visa or MasterCard.**

**Hours of Operation:**

M-TH: 8:00 AM - 6:00 PM EST

FRI: 8:00 AM - 4:30 PM EST

Thank you for choosing this child restraint. The DJG family is committed to creating child restraints with the most comfort and convenience available today.

Remember, parents are a child's first teachers and examples. If you always buckle your seat belt, your child will think it is the natural thing to do. Make it a firm rule that the vehicle does not go until everyone is buckled up. Make no exceptions.

No one can predict if use of a child restraint will prevent injury or death in a particular crash. However, when combined with careful driving, proper use of a child restraint can lower a child's risk of injury or death in most crashes.

If you still have questions or have any concerns with this child restraint, please contact our Consumer Care Department:

**Call:** 1-800-544-1108

**Text:** 1-812-652-2525

**Chat:** [www.safety1st.com](http://www.safety1st.com)

**Hours of Operation:**

M-TH from 8:00 AM to 6:00 PM EST

FRI from 8:00 AM to 4:30 PM EST